

Related Documentation

For complete information on the Thyro-PX unit, see the user manual that accompanied the system. In particular, reference the safety information in Chapter 1 of the user manual for the Thyro-PX unit.

SOFTWARE USER INTERFACE

The optional Thyro-Tool Pro software is available for commissioning and visualization. This software can be used to:

- Update firmware
- Set and display parameters
- Display current operating conditions and events
- Create a time-stamped data record
- Create data charts



Important

Do not start a USB connection while the controller is controlling a critical process. A short output interruption might occur.

Related Links

- [“Using the Software” on page 2](#)
- [“Updating Firmware” on page 8](#)
- [“Linked Variables” on page 11](#)
- [“Thyro-Touch Display” on page 16](#)
- [“Understanding the Display Screen” on page 18](#)
- [“Accessing the Main Menu” on page 19](#)
- [“Thyro-Touch Display Menu Structure” on page 19](#)
- [“AE Global Services” on page 22](#)

USING THE SOFTWARE

Installation

To install the Thyro-Tool Pro software, double-click the .exe file provided by AE. During installation, a server (Windows® service: ThyroWindowsService) and client are installed. The server and client start in parallel when the software is started.

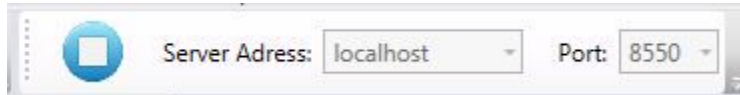

Figure 1. Connection to local installed server

The left side of the window offers a file explorer for opening files and directly connected devices. On the right side, tabs are shown for each subsection that has been selected by double-clicking it. You can switch between the open windows by:

- Double-clicking the file explorer
- Clicking the appropriate tab
- Selecting the desired option from a drop-down menu (overview with icons)

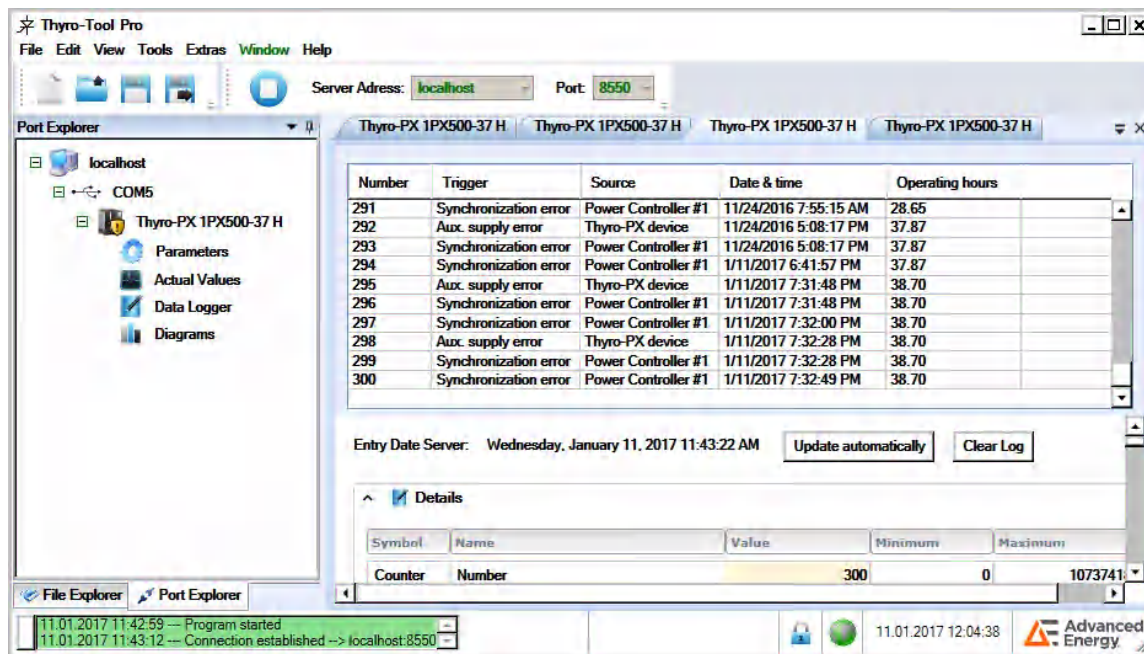

Figure 2. Several open tabs

The field with status messages at the bottom left corner of the screen can be opened as a separate window for an improved overview. Click the button on the left side of the status field to open a separate status message window.

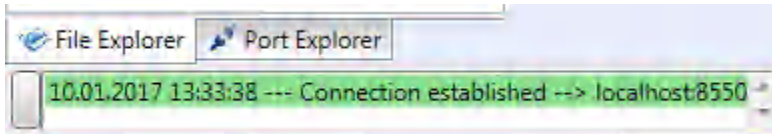

Figure 3. Status message

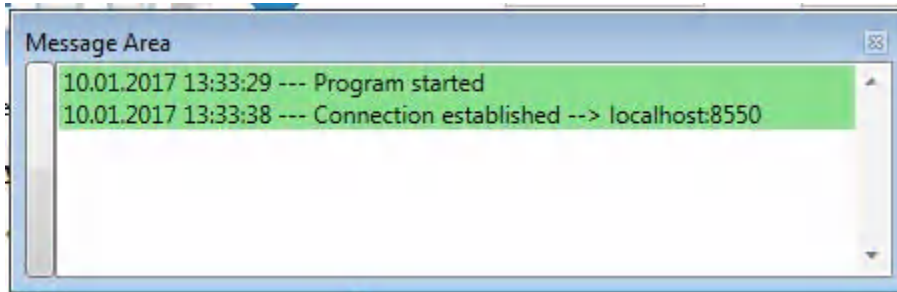

Figure 4. Separate status message window

You can rearrange the tabs within the window to appear as a:

- Horizontal tab group
- Vertical tab group
- Separate window

To change to a horizontal or vertical tab group, right-click on a tab and make the choice. To open a tab in a separate window, click and drag the tab to the desired location.

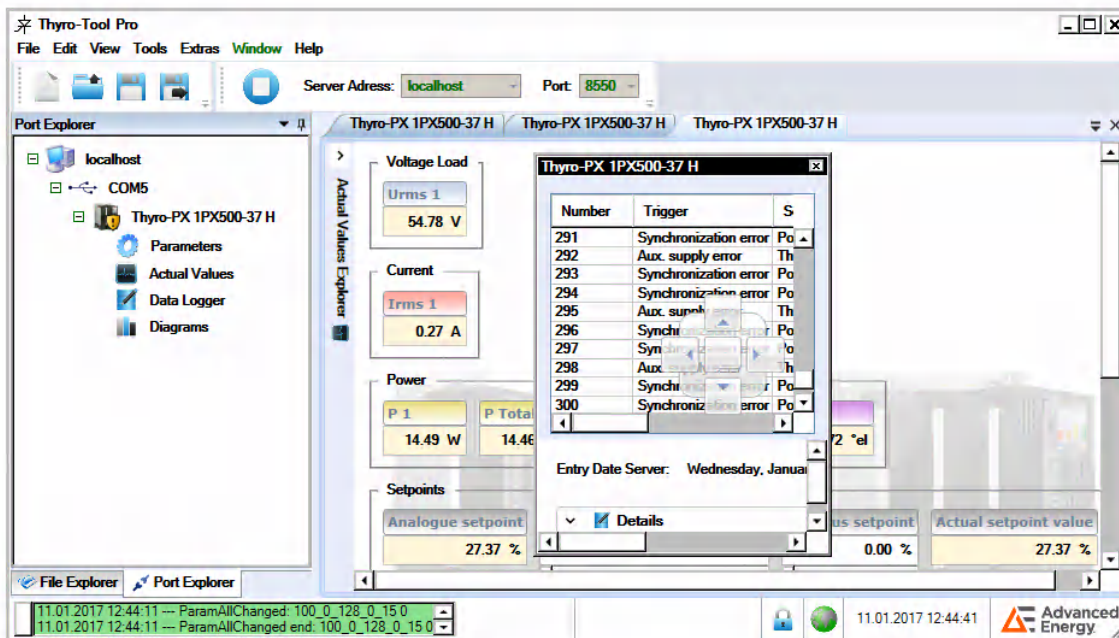

Figure 5. Separate tab

To save the rearranged tabs, select **View**→ **Layout**→ **Save** from the top tool bar.

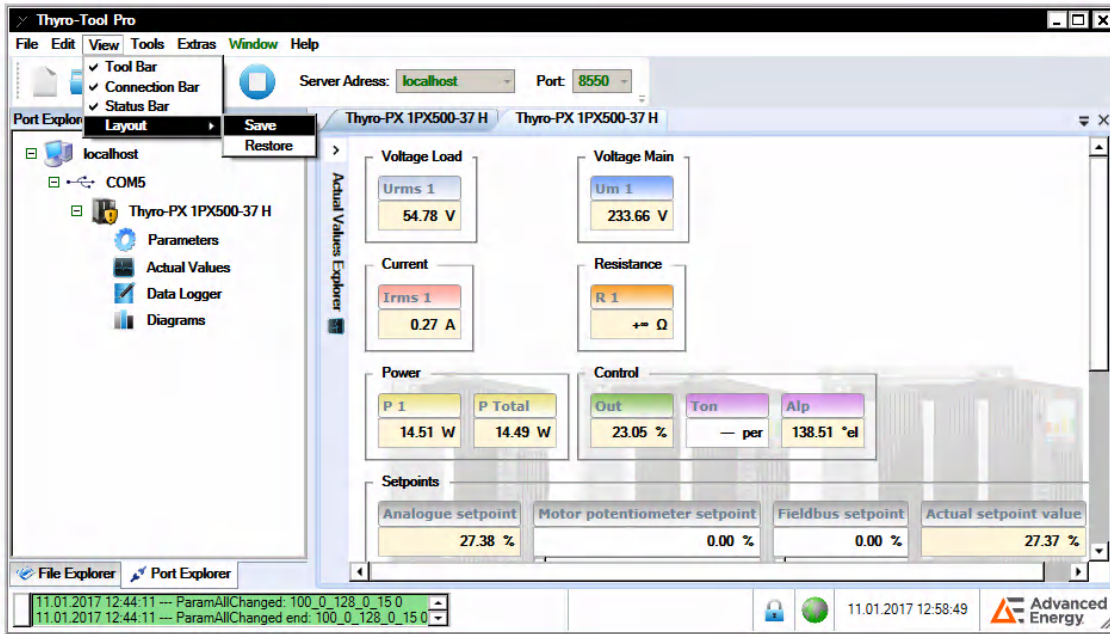



Figure 6. Save or restore layout

Manage Devices and Files

Click the **Port Explorer** tab to show all the Thyro-PX devices connected to the computer. USB connected devices list their virtual COM port. Network connected devices list their IP address. Devices can be connected before and after the software is started.

 **Important**

The first time the specific USB port is connected, the computer must configure the port and load the device driver. This will take up to several minutes.

You can select files with a .thyro file extension using the file explorer or the open icon  from the tool bar. All open files display in the lower pane. The middle pane displays the .thyro files from the selected folder of the upper window.

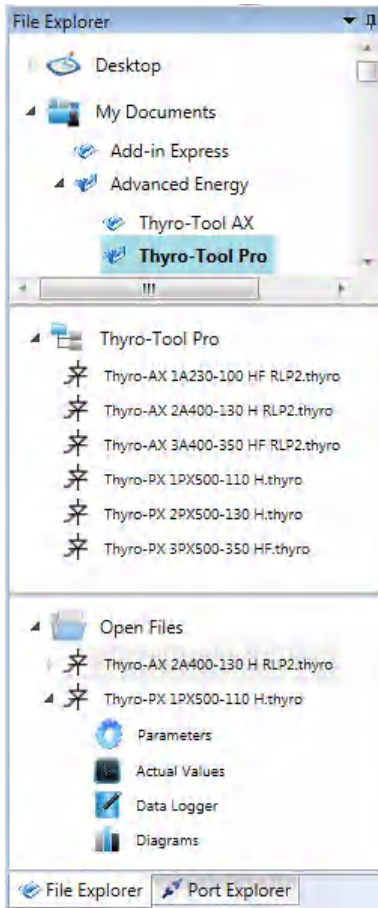

Figure 7. Open .thyro files in file explorer

The following tabs display when an open device is expanded:

- **Parameters** (to change and adjust the performance)
- **Actual Values** (to display the current available data and event messages)
- **Data Logger** (to record messages with time stamp)
- **Diagrams** (to record time-stamped data as characteristic lines)

The .thyro files include parameters, time, data logger entries, and diagrams.

Parameters

Double-click a parameter to open its editable window.

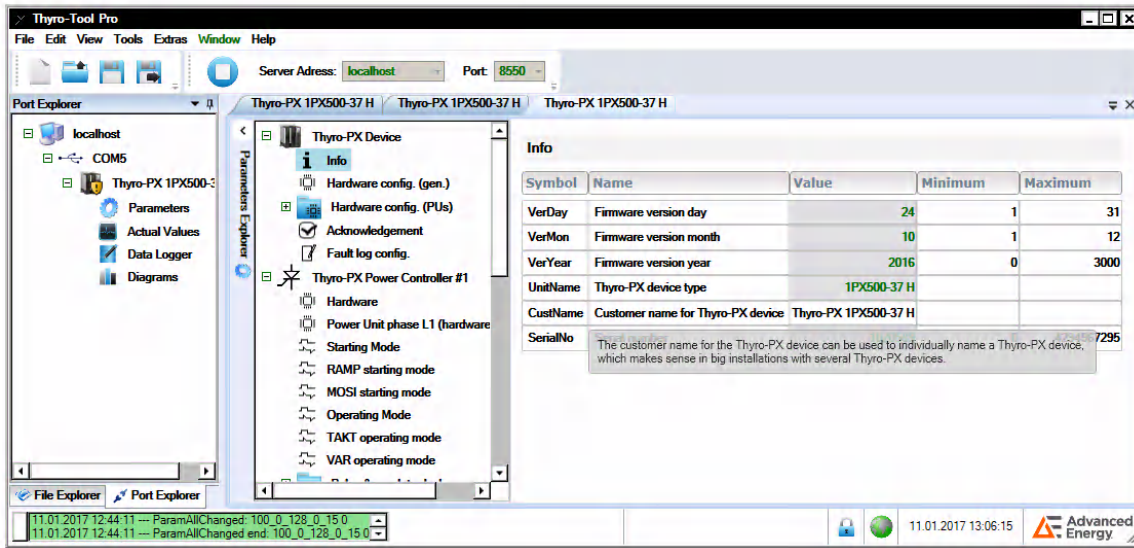



Figure 8. Change name of device

The features are sorted by groups and are changeable via one click on each heading on the right side. A tooltip for each feature describes the effect of the feature and, if appropriate, the default value and valid value range. If you change a value and then select another field, the changed value displays as red.

- A changed value is effective immediately when the device is connected; by default, a changed value reverts to the last saved value on system startup.
- Click the save  icon to save the changed value.

Click the save-as  icon to save parameters to your computer as a .thyro file.

To transfer a local file to the device, the device must be connected and the relevant .thyro file must be open (file will appear in the lower window of the file explorer). A drop-down menu opens with a list of all open files and connections under **Tools**→ **Transfer parameter set**.

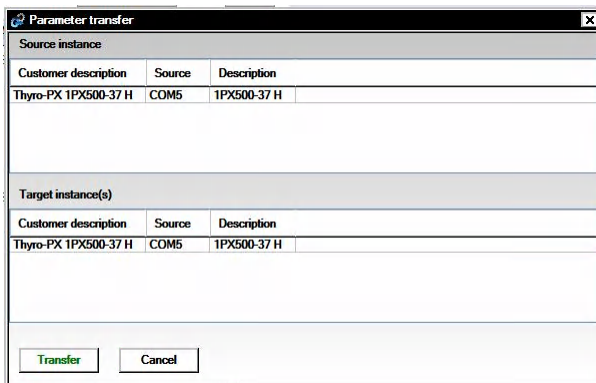

Figure 9. Parameter transfer

The source file displays under **Source instance** and the describe device is displays under **Target instance**. Click the **Transfer** button to start the file transfer. Subsequently the values have to be saved.

There are three entry methods used for parameters:

- Drop-down menus
- Numeric fields
- Check boxes

With drop-down menu parameters, entries are summarized in a list, as shown in the following figure. Select the desired parameter from the drop-down menu.

Operating Mode		
Symbol	Name	Selection
Mode	Operating mode	VAR
Symbol	Name	TAKT
ConfOM	Configuration (regulator behaviour)	No option activated!

Figure 10. Drop-down menu parameter

With numeric-field parameters, a number is entered into a field, as shown in the following figure. In those fields, values are displayed to the second decimal place. For internal purposes, additional decimal places can be entered which will be used for calculation. With mouse-over the precise value of each field can be seen without any limitations. This is of particular importance to control parameters.

PID process controller				
Symbol	Name	Value	Minimum	Maximum
Kp	Kp	0.15	0.00	1.00
Ki	Ki	0.1501235	0.00	1.00
Kd	Kd	0.00	0.00	1.00

Figure 11. Numeric-field parameter

With check-box parameters, a list of possible entries is displayed, as shown in the following figure. Multiple selection is possible and active entries are marked in light green. Active entries are grouped in the overview and non-selected are hidden. These lists are used for selection of messages (events), which should lead to certain actions, or for selection of setpoints, which are added in two switchable, customized configurations and therefore are captured simultaneously in sets.

TAKT operating mode		
Symbol	Name	Code
Config	Configuration	<input checked="" type="checkbox"/> Activate cutting of 1st half-wave (AN1) and deactivate soft-start (SST) <input checked="" type="checkbox"/> Activate minimum off-time and deactivate soft-down (SDN)

Figure 12. Check-box parameter

UPDATING FIRMWARE

Follow these instructions to update the Thyro-PX power controller firmware using the Thyro-Tool Pro software.

To Update Unit Firmware

1. Download the latest version of the Thyro-Tool Pro software.
2. Start the Thyro-Tool Pro software.
3. Connect to the unit using a USB cable.
4. Click the **Port Explorer** tab.
 - If the icon for the unit shows a yellow !, then the unit firmware is not up to date. Continue to update the firmware.

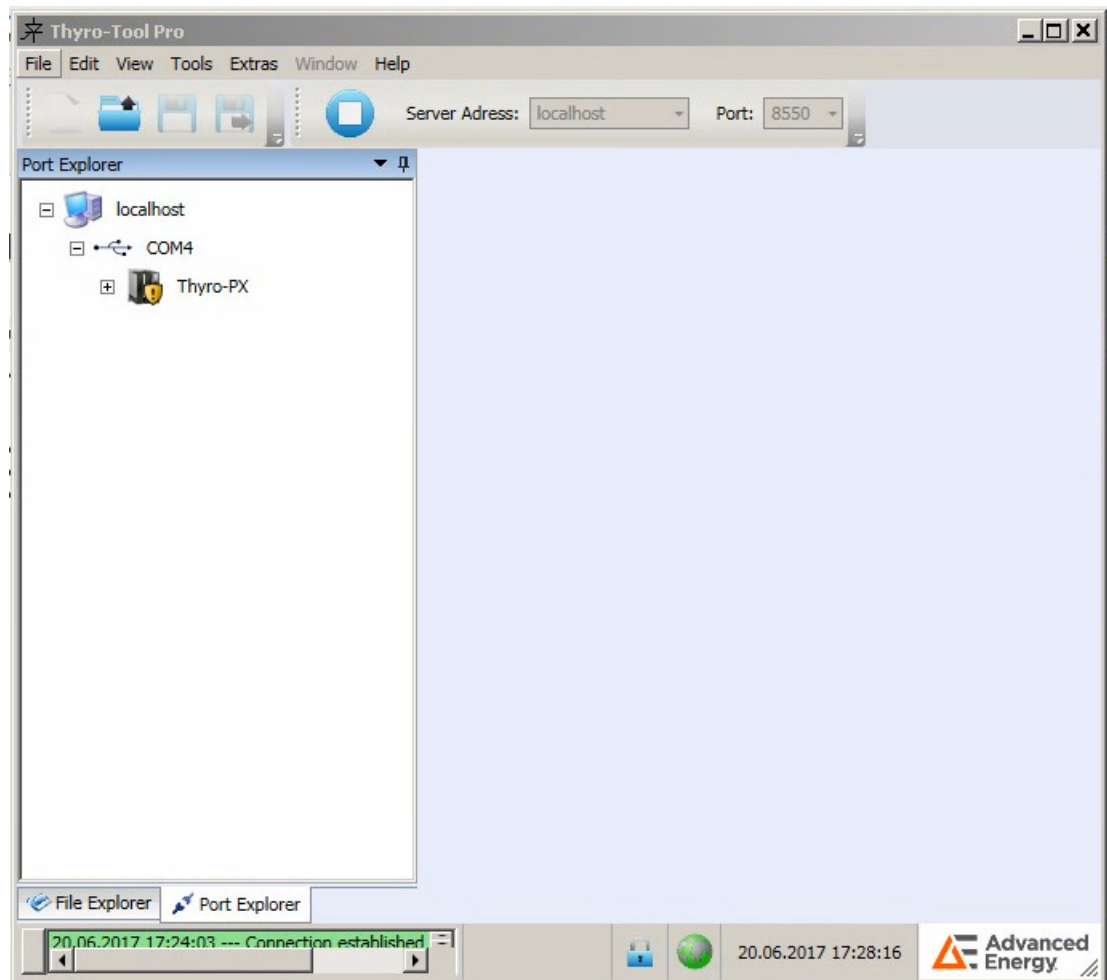

5. Right-click the unit icon, and then click **Update Firmware**.

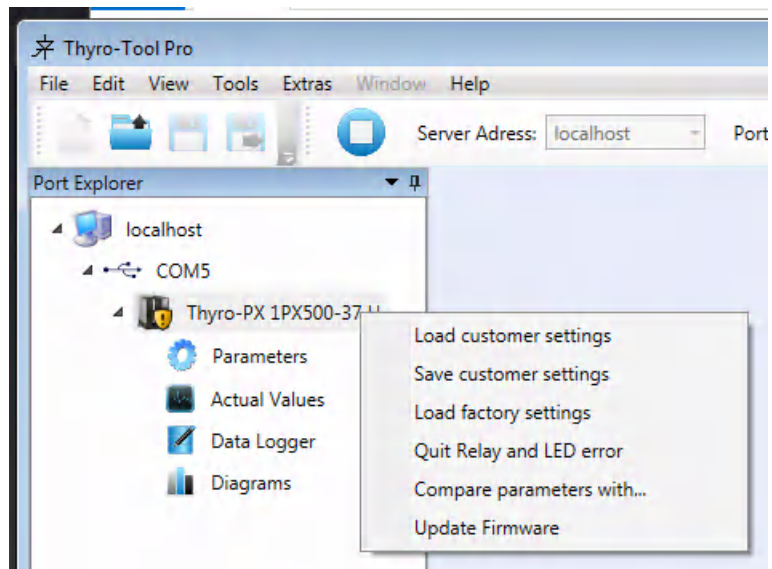

6. Click **Update**.

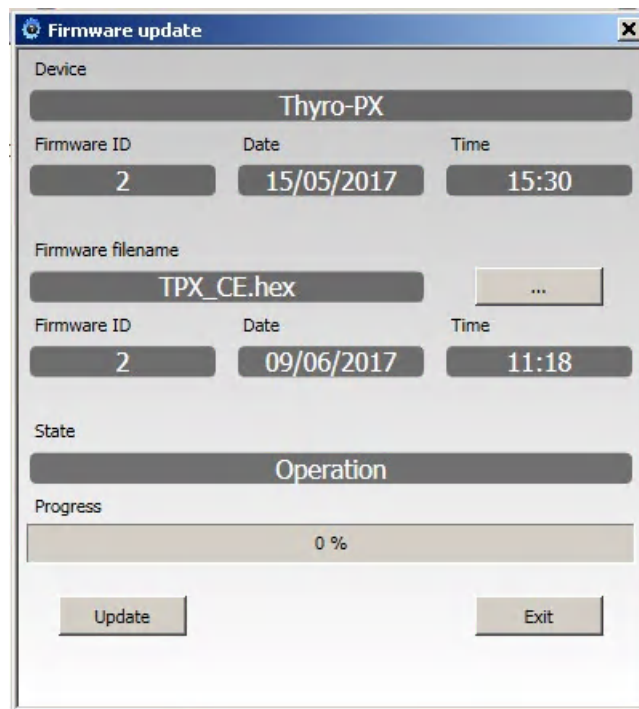

7. Click **Ok**.

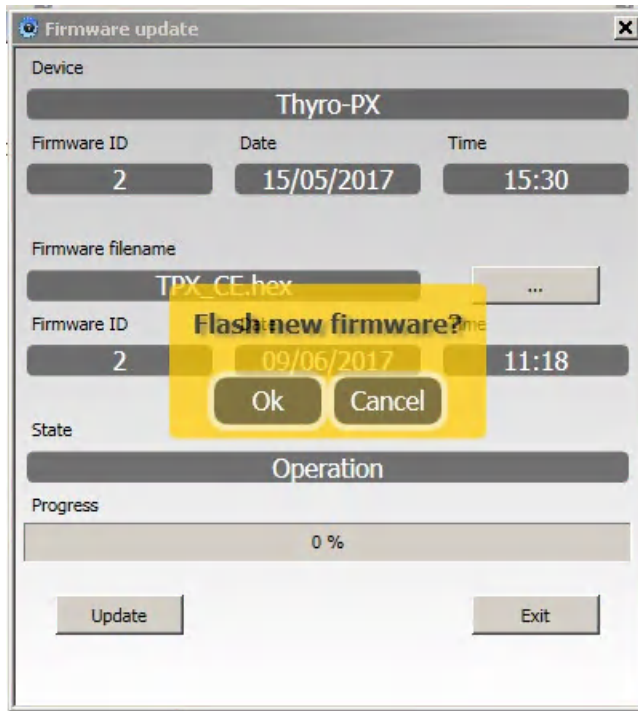

The first LED on the unit flashes yellow while the new firmware is being loaded. The software displays the update progress.

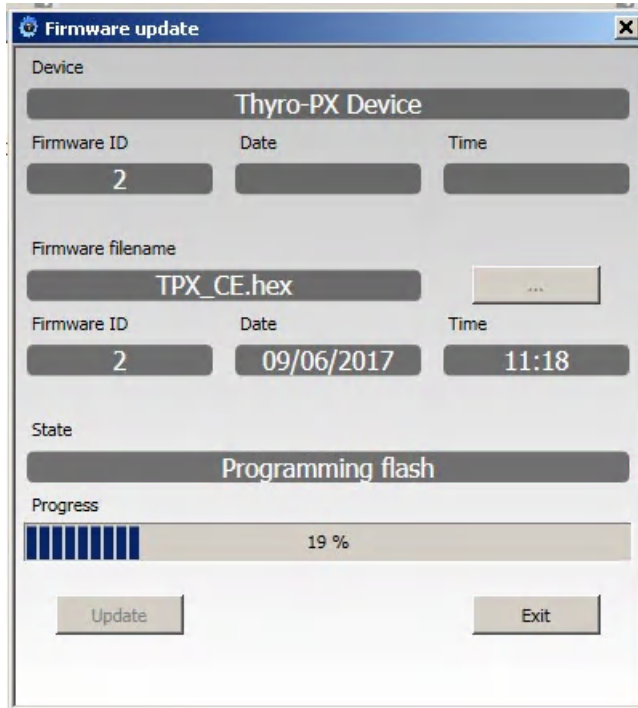

- Click **Ok** when the software indicates that the update is complete.

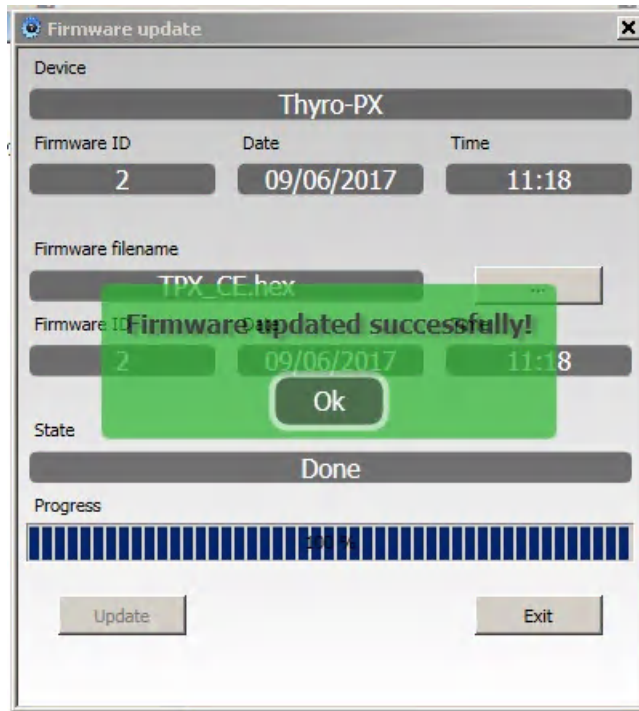

LINKED VARIABLES

You can control and monitor the Thyro-PX power controller using analog and digital inputs and outputs. When a value or state is pulled from the unit to an output, it is called a pull-link variable. When the value or state of an input is pushed to the unit, it is called a push-link variable. Configure these inputs and outputs using the Thyro-Tool Pro software.

To Configure a Pull-Link Variable

The following example shows how a pull-link variable can be used. Use a similar process to configure any other linked variable in the unit. You can view extensive help text screens by positioning the cursor over each parameter.

In this example, you will configure analog output 1.1 (X52.6) to show the voltage on power input L1.

- Start the Thyro-Tool Pro software.
- Connect to the unit using a USB cable.

3. Click the **Port Explorer** tab.

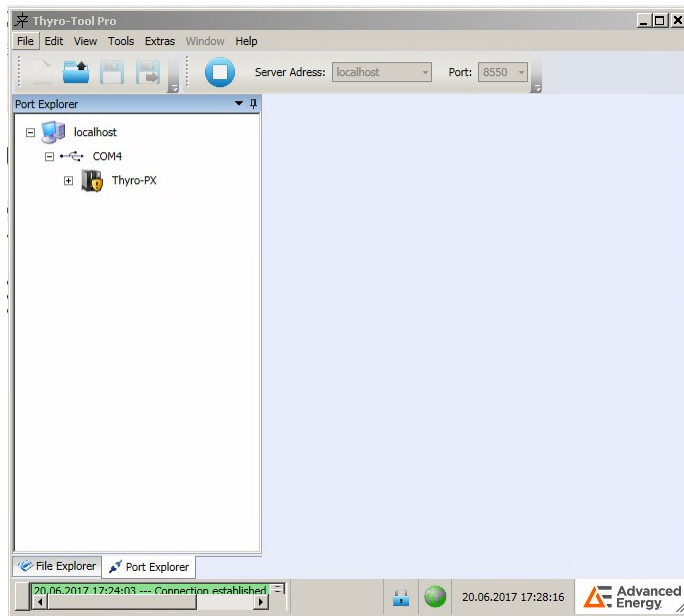

4. Click the + to the right of the unit icon to expand the unit selections.

5. Double-click **Parameters**.

6. Expand **I/Os, LEDs & Relays**.

7. Double-click **Analogue outputs**.

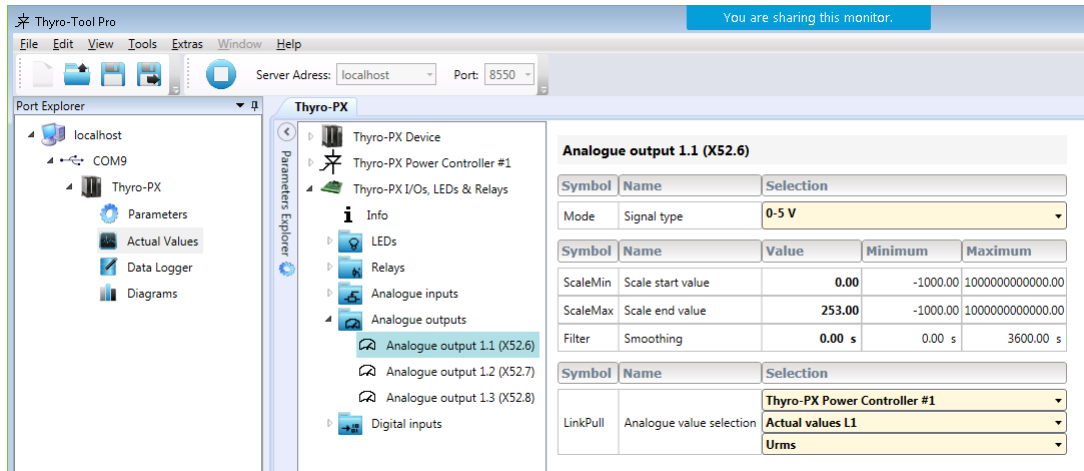

8. Using the pull-down menus:

- a. Select **0-5 V** or your preferred signal type.
- b. Select **Thyro-PX Power Controller #1**.
- c. Select **Actual values L1**.
- d. Select **Urms**.

9. Click the save icon  to save the new configuration.

To Configure a Push-Link Variable

The following example shows how a push-link variable can be used. Use a similar process to configure any other linked variable in the unit. You can view extensive help text screens by positioning the cursor over each parameter.

In this example, you will configure analog input 1.1 (X52.2) to push an external analog setpoint to the unit.

1. Start the Thyro-Tool Pro software.
2. Connect to the unit using a USB cable.
3. Click the **Port Explorer** tab.

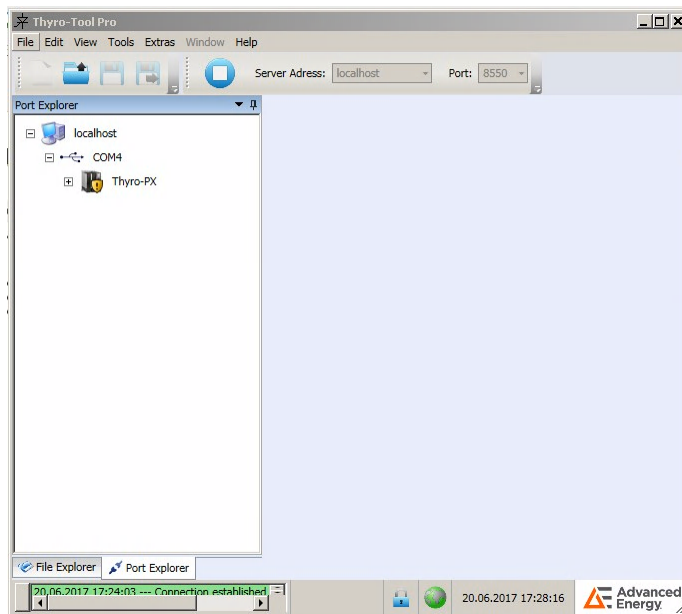

4. Click the + to the right of the unit icon to expand the unit selections.
5. Double-click **Parameters**.
6. Expand **I/Os, LEDs & Relays**.

7. Double-click **Analogue inputs**.

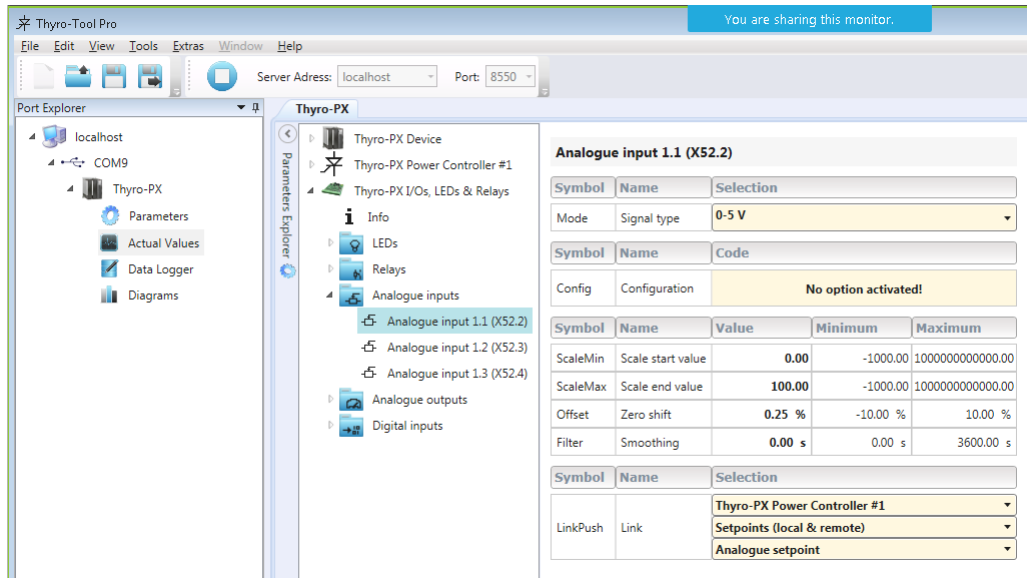

8. Using the pull-down menus:
 - a. Select **0-5 V** or your preferred signal type.
 - b. Select **Thyro-PX Power Controller #1**.
 - c. Select **Setpoints (local & remote)**.
 - d. Select **Analogue setpoint**.
9. Click the save icon  to save the new configuration.

To Configure a Push-Link Variable to Change Operating Mode

The following example shows how a push-link variable can be used to change the operating mode. Use a similar process to configure any other linked variable in the unit. You can view extensive help text screens by positioning the cursor over each parameter.

In this example, you will configure digital input 1.3 (X51.5) to change the operating mode from TAKT to VAR based on the state of the digital input.

1. Start the Thyro-Tool Pro software.
2. Connect to the unit using a USB cable.

3. Click the **Port Explorer** tab.

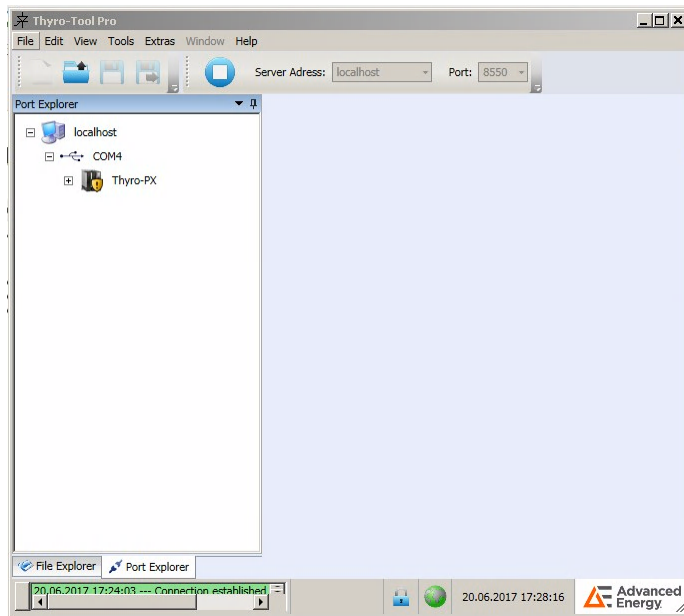

4. Click the + to the right of the unit icon to expand the unit selections.
5. Double-click **Parameters**.
6. Expand **I/Os, LEDs & Relays**.
7. Double-click **Digital inputs**.
8. Using the pull-down menu, configure digital input 1.3 to control operating mode.

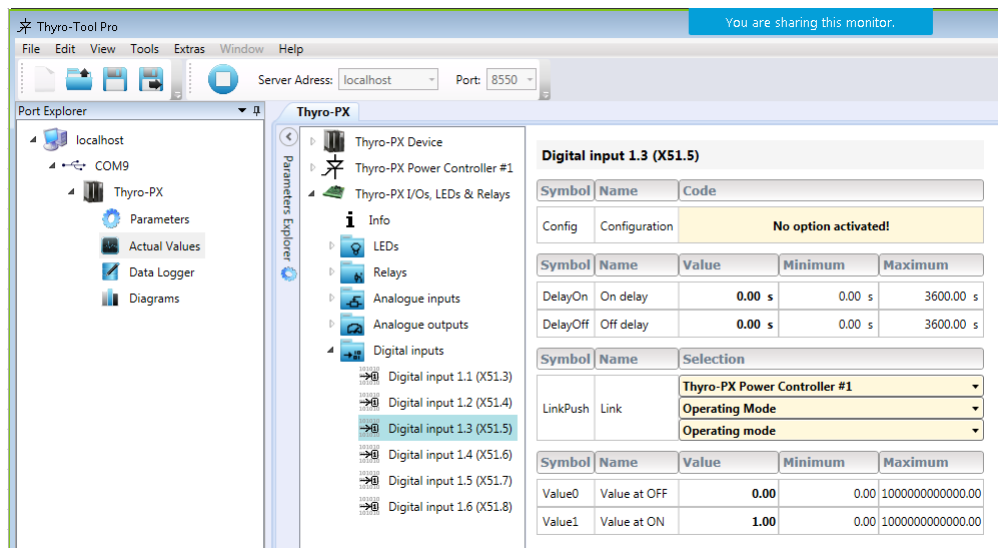

9. Click the save icon  to save the new configuration.

10. Verify that the state of the operating mode follows the digital input.
 - a. Double-click **Actual Values**.
 - b. Double-click **Operating Mode**.

The color of the operating mode value changes from blue to orange, indicating that the value is controlled by an external input. The operating mode is **TAKT** when the digital input is low, and **VAR** when the digital input is high.

Important

When a push-link is configured to write to a variable on the unit, the variable can no longer be changed by the Thyro-Tool Pro software, Thyro-Touch display, or bus interface.

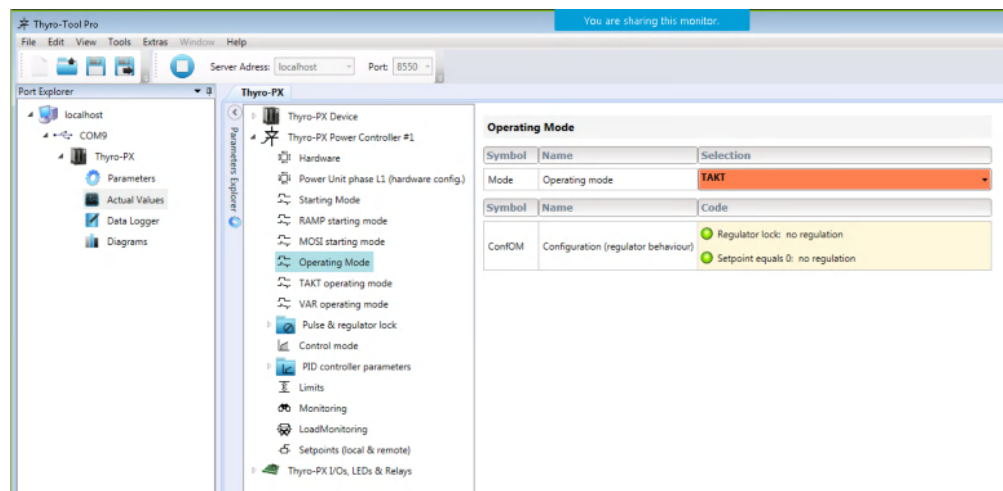

THYRO-TOUCH DISPLAY

The Thyro-Touch display is an optional accessory for the parameterization and visualization of measured values, such as current, voltage, power, and setpoint.



Figure 13. Thyro-Touch display

In addition to simplifying the handling of the Thyro-PX power controller, the Thyro-Touch display also offers a quick overview of power controller status. Ongoing data can also be displayed as line or bar charts. The integrated data recorder enables a long-term recording of up to six measured values, including status messages. You can evaluate the data on a PC. The **EasyStart** feature simplifies the setting of the power controller configuration.

The Thyro-Touch display includes an SD® memory card, and supports Bluetooth® low energy wireless communication.

The Thyro-PX power controller provides a communications interface through the **X10** port. This interface allows you to monitor and control the unit through an optional touch display. The display features include:

- Standard languages: German, English. Additional languages are available on request.
- Configure setpoints, actual values, parameters, and status messages.
- Display setpoints and measured process values as a line chart, bar chart, or operating-data display.
- Log process data for long-term data recording, including evaluation of min./max. data curve (easy to convert data into Excel® format).
- Load and save the power controller parameter setting to an SD Memory Card.

- The display can either be connected directly to the power controller, or connected remotely with the cabinet installation kit (SEK).

Warnings are highlighted in yellow, and error messages are highlighted in red on the display. Click on a message to see details directly in the fault log.

The following access levels apply:

- Level 1 PIN: 160387, access to parameter settings
- Level 2 PIN: 311263, access to detailed power controller parameterization

Understanding the Display Screen

When you first supply power to the unit, the **EASYSTART** menu appears. On subsequent starts, the user-defined default start screen appears.

EASYSTART

This menu enables you to easily configure the Thyro-PX power controller for initial use, by answering a series of questions. For details on the EasyStart function and its selection possibilities, see [Figure 15](#) on page 21.

When you first start the Thyro-Touch display, the EasyStart screen will be displayed. Once the EasyStart sequence has been completed successfully on the unit, it will not appear again. EasyStart can be selected at any time if required via the display menu.





START SCREEN

The default start screen is user configurable. It can be switched to:

- Line chart (6 values, optional)
- Operation display (6 values, optional)
- Bar chart (4 values, optional)
- Data logger

The values that have been selected for the line chart, are saved as process data on the SD card.

The four soft keys on the bottom of the start screen have the following functions:

	The home key returns you to the start screen from any submenu.
	The list key displays the main menu, from which you can access further menus to configure the display and the power controller.
	The off key operates as a data backup before shutting down the Thyro-Touch display. The display must be shut down in order to save all settings and data prior to removing the display from the power controller.
	The logo key switches the display between the line chart, bar chart, operation, and data logger screens.

Accessing the Main Menu

When you connect the display, it shows the information determined by the start screen configuration.

The Thyro-Touch display allows you to access menus and to make menu selections. When a menu selection causes the display to show a parameter, you can use the display to set the parameter value.

TO ACCESS THE MAIN MENU AND OTHER MENUS

1. Press a soft key to cause another level of menu choices to display.

For example, pressing the list menu icon soft key displays the next menu level: **configure the display** and **configure the power controller**.

Press the  icon to return to the main menu.

Thyro-Touch Display Menu Structure

Pressing the  soft key will bring up the configuration menu tree. At the top level, you have eight menu options:

- **Settings**
- **EasyStart**
- **Actual values**
- **Data logger**
- **Line chart**
- **Load/save data**
- **Acknowledge errors**
- **Reset data logger**

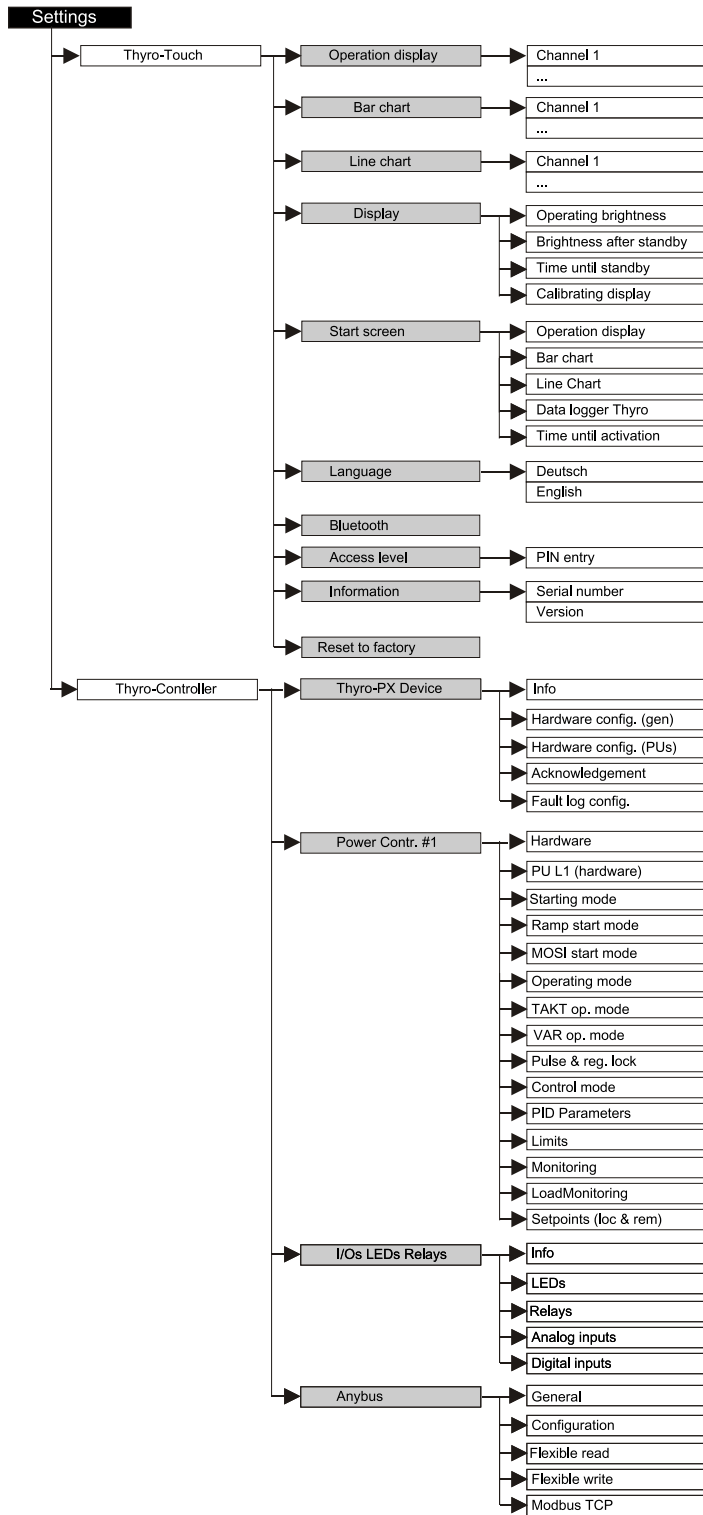

Figure 14. Settings menu map

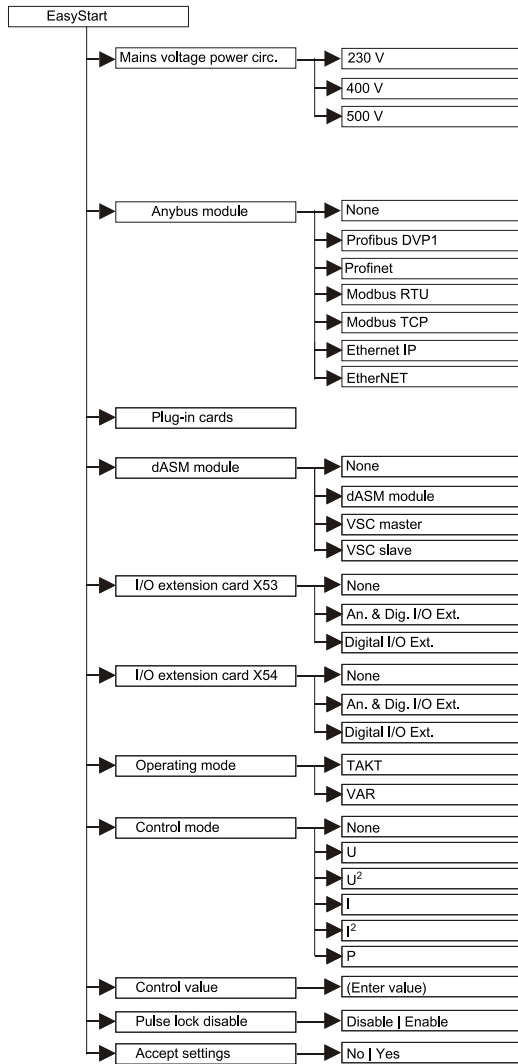

Figure 15. EasyStart menu map

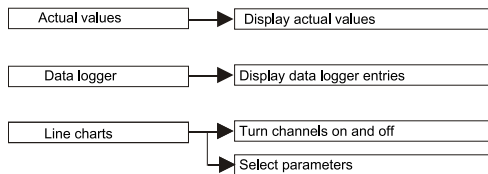

Figure 16. Actual Values, Data logger, Line charts menu map

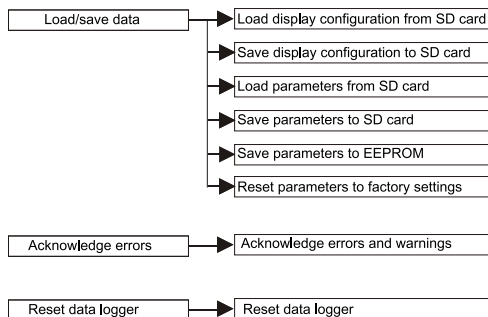

Figure 17. Load/save, Acknowledge errors, Reset data logger menu map

AE GLOBAL SERVICES

Please contact AE Global Services if you have questions or problems that cannot be resolved by working through the provided troubleshooting. When you call Global Services, make sure to have the unit serial number and part number. These numbers are available on unit labels.



Important

For returns and repairs, please call AE Global Services to get the correct shipping address.

Table 2. AE Global Services 24 X 7 contact information

Office	Contact
AE World Headquarters	Address: 1625 Sharp Point Drive Fort Collins, CO 80525 USA Phone (24 hrs/day, 7 days/week): 800.446.9167 or +1.970.221.0108 Email: (We will respond to email by the next business day.) mailto:technical.support@aei.com
Thermal product support	Contact by phone or email: +1.360.694.7871 mailto:thermalapplications@aei.com
Power Control Module product support	Contact by phone or email: +49 (0) 2902 910370 10 (technical support during German business hours) mailto:powercontroller@aei.com
High Voltage product support: HiTek Power, Ltd.	Contact by phone or email: +44 (0) 1903 712400 mailto:support.centre@aei.com
High Voltage product support: UltraVolt, Inc.	Contact by phone or email: +1.631.471.4444 mailto:sales.support-uv@aei.com

Table 2. AE Global Services 24 X 7 contact information (Continued)

Office	Contact
Local or regional sales or service office	Visit the Advanced Energy website for current contact information: http://www.advanced-energy.com

TRADEMARKS

All Advanced Energy trademarks are the property of Advanced Energy Industries, Inc. For the list of Advanced Energy trademarks, visit <http://www.advanced-energy.com/en/Trademarks.html>. Any unauthorized use of Advanced Energy trademarks is prohibited.

All other trademarks are the property of their respective owners.